

DISE-P

dobradiças injetadas  
injected hinges  
bisagras inyectadas



semi embutida – semi embedded – semi embutida

poliamida 6 – polyamide 6 – poliamida 6



**Fixação**

Por parafuso cabeça chata M4 em aço zincado (não incluso no fornecimento) e pino de giro em poliacetal.

**Fixing**

By M4 flat head zinc plated steel screw (not included) and polyacetal spin pin.

**Fijación**

Por tornillo cabeza plana M4 en acero cincado (no incluido en el suministro) y eje de giro en poliacetal.

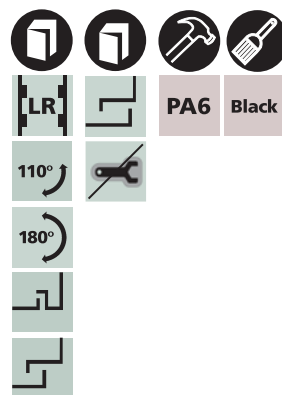

PA6 Black

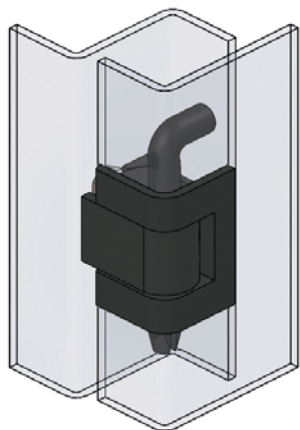

DISE-PP

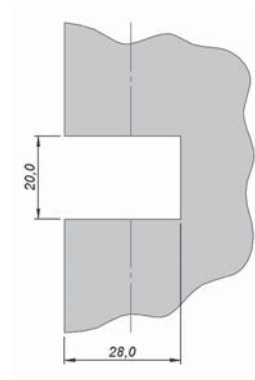
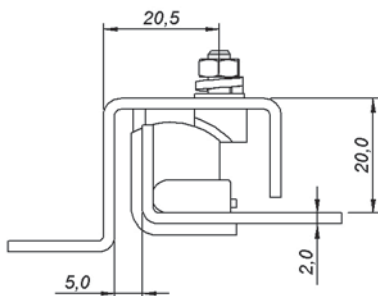
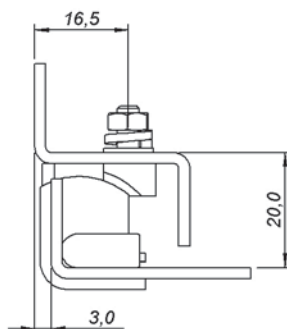
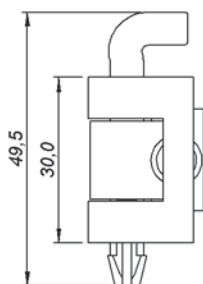

recorte de fixação  
cut out  
corte de fijación

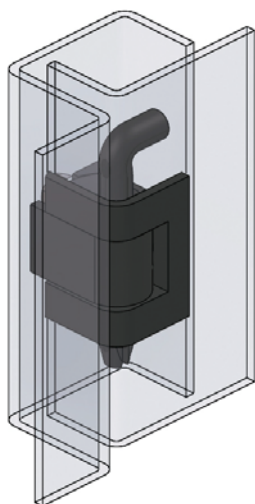

DISE-PP

MODELO – MODEL – MODELO	CÓDIGO – CODE – CÓDIGO
DISE-PP	40.244.001

dobradiças hinges bisagras