

DISE-Z

dobradiças injetadas injected hinges bisagras injectadas



semi embutida – semi embedded – semi embutida

zamac – zamac – zamac

Fixação

Por parafuso M6 x 12 em aço zincado (incluso no fornecimento).

Fixing

By M6 x 12 zinc plated steel screw (included).

Fijación

Por tornillo M6 x 12 en acero cincado (incluido en el suministro).

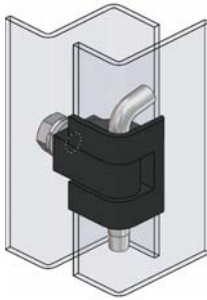
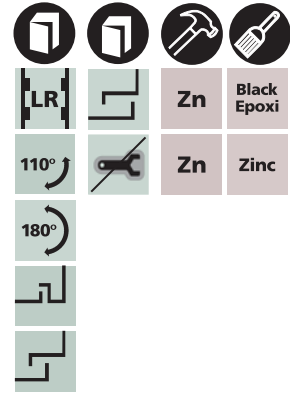

DISE-ZP/D20

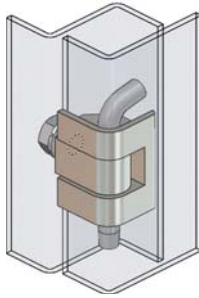

DISE-ZZ/D20

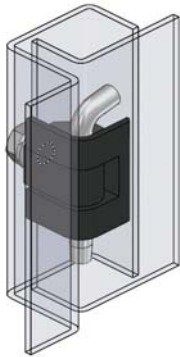

DISE-ZP/D25

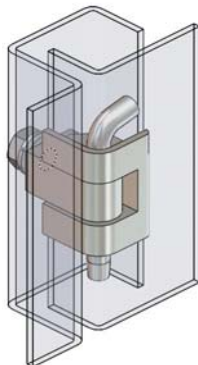

DISE-ZZ/D25

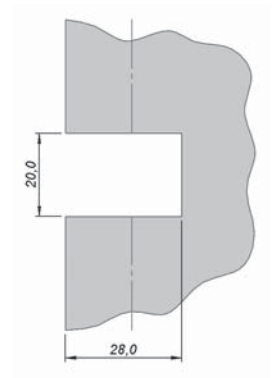
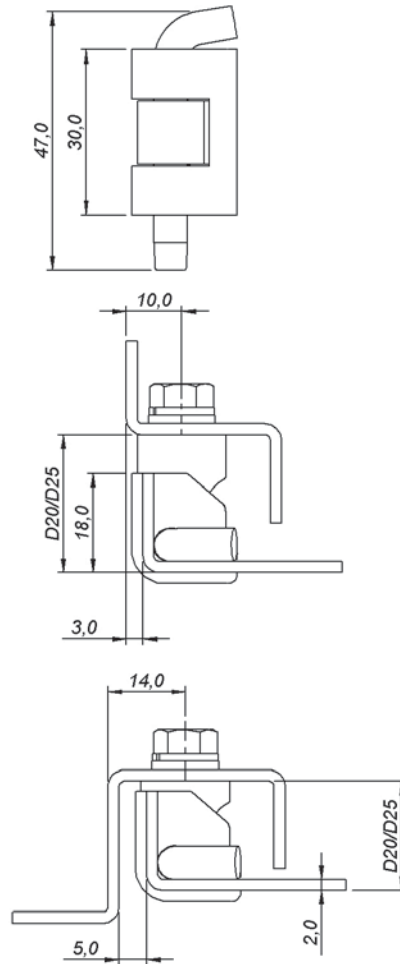

recorte de fixação
cut out
corte de fijación

MODELO – MODEL – MODELO	CÓDIGO – CODE – CÓDIGO
DISE-ZZ/D20	40.288.201
DISE-ZZ/D25	40.288.202
DISE-ZP/D20	40.233.201
DISE-ZP/D25	40.233.202